

ROBERTS

Sound for Generations

ecologic 5

DAB/FM RDS digital clock radio with dual alarm

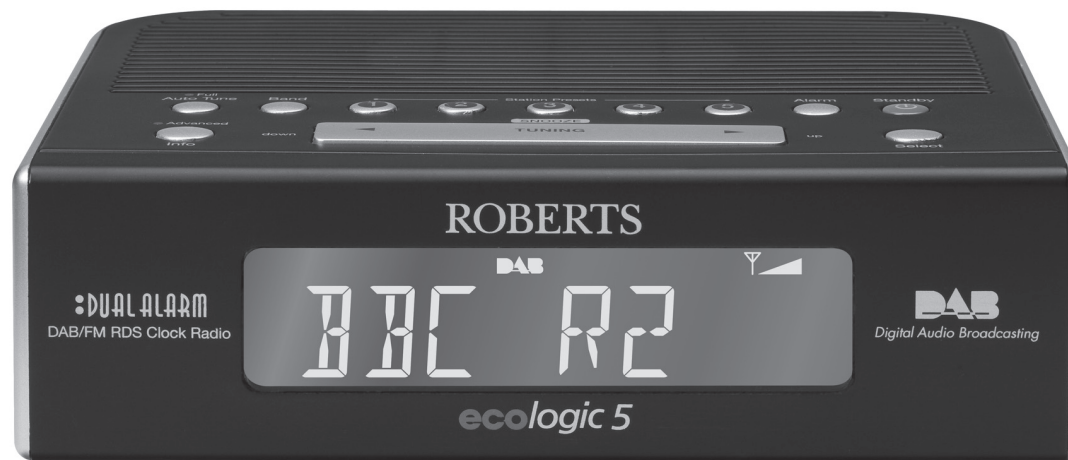

DAB

Digital Audio Broadcasting



Please read this manual before use

Contents

<i>Controls</i>	2-3	<i>Sleep timer</i>	22
<i>Using the clock radio for the first time</i>	4	<i>Set the clock manually</i>	23-24
<i>Operating your clock radio</i>	5	<i>To return to auto set mode</i>	25
<i>Selecting a station - DAB</i>	6	<i>Auxiliary in socket</i>	26
<i>Secondary services - DAB</i>	7	<i>Headphone socket</i>	27
<i>Display modes - DAB</i>	7-8	<i>Line out socket</i>	27
<i>Finding new stations - DAB</i>	9	<i>Software version</i>	28
<i>Manual tuning - DAB</i>	10	<i>System reset</i>	29
<i>Dynamic range control (DRC) settings - DAB</i>	11	<i>Cautions</i>	30
<i>Operating your radio - FM auto-tune</i>	12	<i>Specifications</i>	31
<i>Manual tune - FM</i>	13	<i>Circuit features</i>	31
<i>Display modes - FM</i>	14	<i>Notes</i>	32
<i>Presetting stations</i>	15	<i>Guarantee</i>	34
<i>Recalling a preset station</i>	15		
<i>Clock display</i>	16		
<i>Display backlight</i>	16		
<i>Display Dimmer</i>	16		
<i>Setting the alarm times</i>	17-19		
<i>To view the alarm settings</i>	20		
<i>Cancelling alarms</i>	20		
<i>Snooze</i>	21		
<i>Setting the snooze time</i>	21		

Controls (Top)

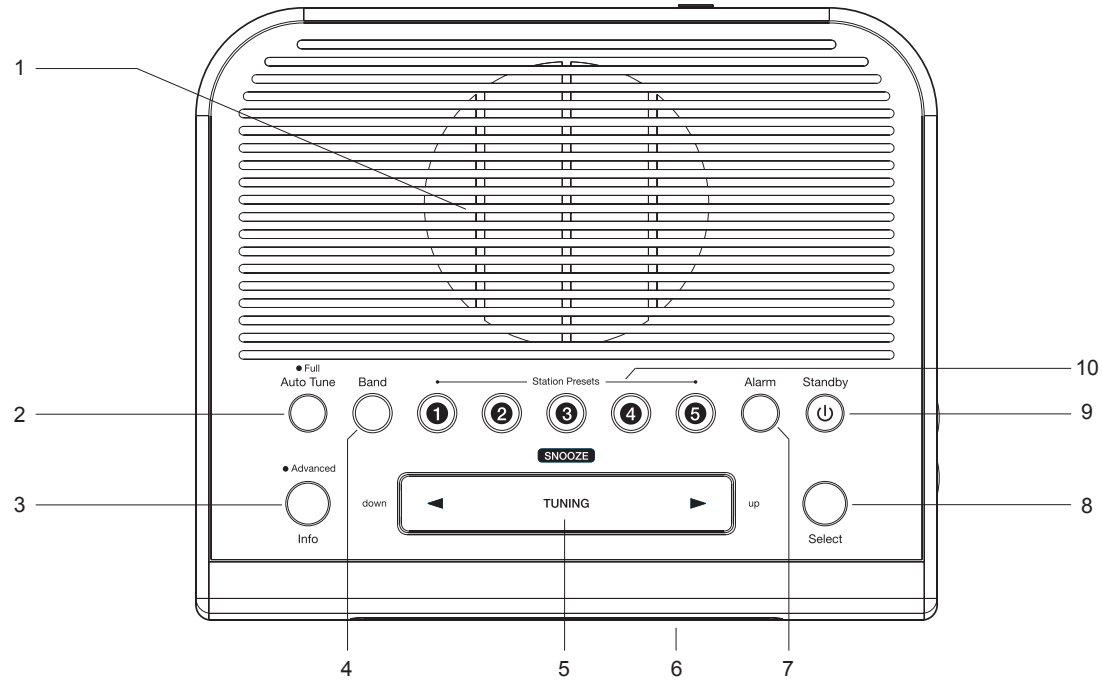

- | | |
|-------------------------------------|----------------------------|
| 1. Loudspeaker | 6. LCD display |
| 2. Auto-tune button | 7. Alarm button |
| 3. Info button | 8. Select button |
| 4. Band button | 9. On / Standby button |
| 5. Tuning Up / Down / Snooze button | 10. Station preset buttons |

Controls (right hand side)

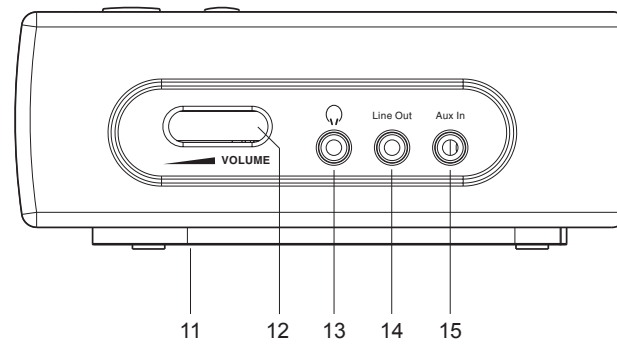

- 11. Display dimmer control
(under radio)
- 12. Volume control
- 13. Headphone socket
- 14. Line out socket
- 15. Auxiliary in socket

Controls (rear)

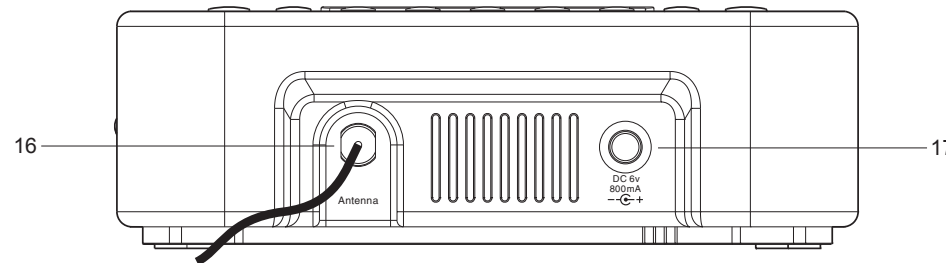

- 16. Wire DAB/FM aerial
- 17. DC jack socket

Using the clock radio for the first time

1. Place your clock radio on a flat surface.
2. Fully extend the wire aerial located on the rear of your clock radio. Place the wire antenna so that it is as straight as possible extending either above or below the radio.
3. Insert the adaptor plug into the DC socket located on the rear of your clock radio. Plug the adaptor into a standard 13 amp mains socket outlet. The display will show "ROBERTS" for a few seconds and then the display will then show "SET CLOCK". During this time the radio is scanning to find out which DAB radio stations are available. After a short time the current time will appear on the display.
4. If no stations are found, "NO CLOCK" will be displayed. It may be necessary to relocate your clock radio to a position giving better reception. You should then carry out a scan to find stations as described on page 9.

IMPORTANT: The mains adaptor is used as the means of connecting the clock radio to the mains supply. The mains socket used for the clock radio must remain accessible during normal use. In order to disconnect the clock radio from the mains completely, the adaptor should be removed from the mains socket outlet completely.

Characters appearing on the LCD display indicate that the radio is connected to and powered from the mains supply.

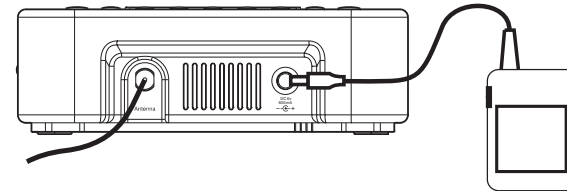

ROBERTS

SETCLOCK

14:03

NO CLOCK

Operating your clock radio

1. Press the **On / Standby button** to switch on your clock radio. The display will show "TUNING" for a few seconds.

When first switched on, the radio will be in DAB mode. After each use the radio will remember the mode used and then switch on in that mode the next time that it is used.

2. If the clock radio has been used before, the last used station will be selected.
3. If this is the first time that the radio has been used, then the first station in the list of stations found during scanning will be played. The display will show the station name on the display.
4. If no signals are found then "OFF AIR" will be displayed and it may be necessary to relocate your clock radio to a position giving better reception. You should then carry out a scan to find stations as described on page 9.

- Your clock radio has a indicator  on the display to indicate the strength of the signal being received.
- The display will revert to a conventional time display 10 seconds after the last button press except when displaying scrolling text.

Note: If you can see the name of the radio station on the display, but cannot hear any sound, you may need to adjust the volume control which is located on the right hand side of your clock radio.

Standby

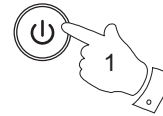

Selecting a station - DAB

1. Press the **On / Standby button** to switch on your clock radio. The display will show "TUNING" for a few seconds.
2. Press the **Band button** to select DAB mode. The display will show the name of the radio station currently selected.
3. Press the **Tuning Up or Down buttons** to step through the list of available stations.
4. When the desired station name appears on the display, press the **Select button** to select the station. The display will show "TUNING" while your radio finds the new station.
5. Adjust the **Volume control** to the required setting.

Note: If after selecting a station the display shows "OFF AIR" it may be necessary to relocate your radio to a position giving better reception.

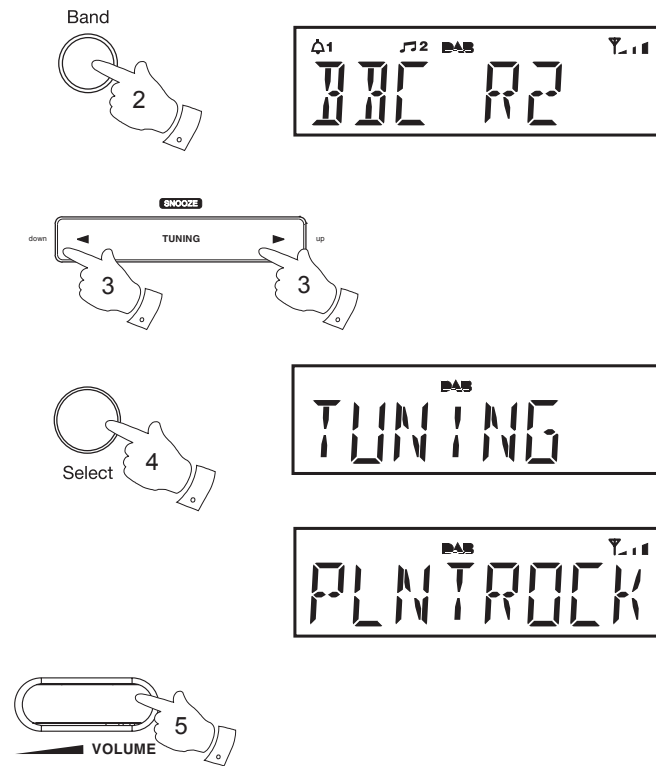

Secondary services - DAB

1. Certain radio stations have one or more secondary services associated with them. If a station has a secondary service associated with it then the secondary service will then appear immediately after the primary service as you press the **Tuning Up button**.
2. To tune to the secondary service, press and release the **Select button**. Most secondary services do not broadcast continually and if the selected service is not available, the radio will re-tune to the associated primary service.

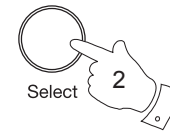
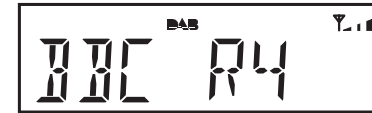
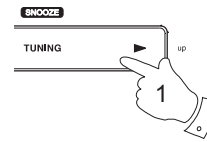

Display modes - DAB

Your radio has a range of display options when in DAB mode. Note that the display will revert to a conventional time display 10 seconds after the last button press except when displaying scrolling text.

1. Press the **Info button** to cycle through the various options.
 - a. Station name Displays the name of the station being listened to.
 - b. Scrolling text Displays scrolling text messages such as artist/track name, phone in number, etc.
 - c. Programme type Displays type of station being listened to e.g. Pop, Classic, News, etc.

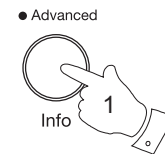

- d. Multiplex Name Displays the name of the DAB multiplex to which the current station belongs.
- e. Time Displays the current time (24 hour clock).
- f. Date Displays the current date.
- g. Day Displays the current day of the week.
- h. Frequency and channel Displays frequency and channel number for the currently tuned DAB station.
- i. Bit rate Displays the digital audio bit rate for the currently tuned DAB station.
- j. Signal error Displays the bit error rate for the currently tuned DAB station.

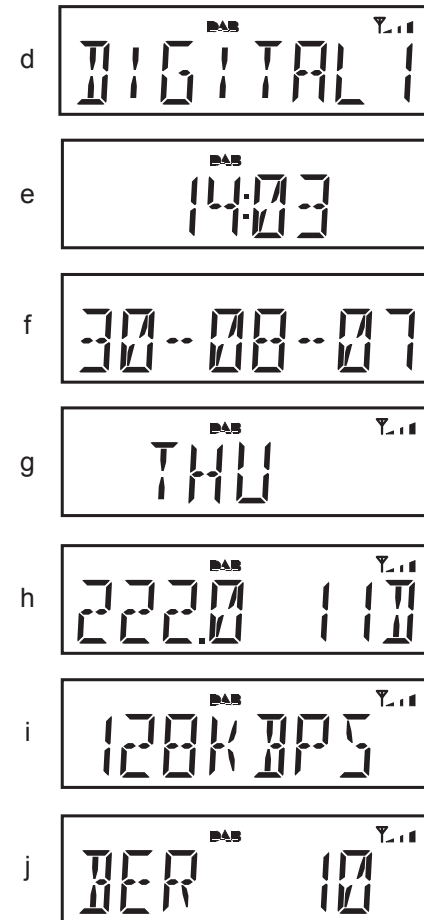

Finding new stations - DAB

From time to time, new DAB radio stations may become available. Or you may have moved to a different part of the country. In this case you may need to cause your radio to scan for new stations.

1. With the radio switched on and in DAB mode press and release the **Auto-Tune button**. "SCANNING" will show on the display.
2. Your clock radio will perform a scan of the UK DAB frequencies. As new stations are found, the station counter on the right-hand side of the display will increase and stations will be added to the list.

In countries other than the UK, in order that the radio may find the available stations it is recommended to carry out a full scan of the entire DAB Band III frequencies. In this case proceed as follows.

3. With the radio switched on and in DAB mode press and **hold** the **Auto Tune button** for 2 seconds until "SCANNING" shows on the display.
4. Your radio will perform a full scan of the DAB band III frequencies. As new stations are found, the station counter on the right-hand side of the display will increase and stations will be added to the list.

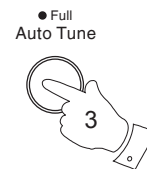
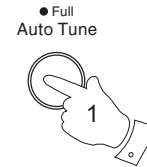

Manual tuning - DAB

Manual tuning allows you to tune your radio to a particular DAB frequency in Band III. Any new stations found will be added to the station list. This function can also be used to assist the positioning of the aerial or radio to optimise reception for a specific channel or frequency. Note that UK DAB stations are located in the range of channels 11B to 12D.

1. Press and hold the **Info button** for 2 seconds so that the display shows "MANUAL".
2. Press and release the **Select button** to enter manual tuning mode.
3. Press the **Tuning Up** or **Down buttons** to select the desired DAB channel. Press and release the **Select button** to tune to the chosen frequency.
If a signal is present then the channel number and the first part of the DAB multiplex name will be displayed.
4. Press and release the **Select button** again to return to the normal DAB tuning mode.

● Advanced

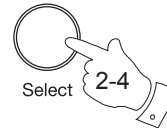
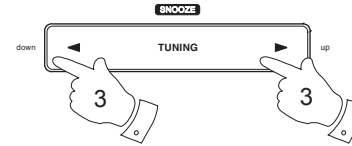
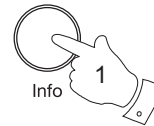

Dynamic Range Control (DRC) settings - DAB

The DRC facility can make quieter sounds easier to hear when your radio is used in a noisy environment.

There are three levels of DRC compression:

- DRC0 No compression applied
- DRC 1/2 Medium compression applied
- DRC1 Maximum compression applied (default)

1. Press the **On / Standby button** to switch on your clock radio.
2. Press the **Band button** to select the DAB band.
3. Press and hold the **Info button** until the display shows "MANUAL."
4. Press the **Tuning Up** or **Down button** until "DRC VAL" appears on the display. Then press the **Select button**. The display will show the current DRC value.
5. Press the **Tuning Up** or **Down buttons** to select required DRC setting.
6. Press and release the **Select button** to confirm the setting. The display will return to the normal radio display.

Note: Not all DAB broadcasts are able to use the DRC function. If the broadcast does not support DRC, then the DRC setting in the radio will have no effect.

Standby

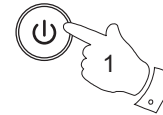

Band



• Advanced

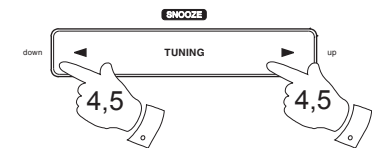
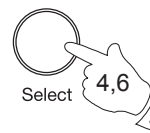

Operating your radio - FM auto-tune

1. Fully extend the wire aerial located on the rear of your clock radio. Place the wire antenna so that it is as straight as possible extending either above or below the radio.
2. Press the **On / Standby button** to switch on your clock radio.
3. Press the **Band button** to select the FM band.
4. Press and release the **Auto Tune button**. Your radio will scan from low frequency to high frequency (or in the direction last scanned). It will stop automatically when it finds a station of sufficient strength.

5. After a few seconds the display will update. The display will show the frequency of the signal found. If the signal is strong enough and there is RDS data present then the radio will display the station name.

Note that the radio will switch to the time display after 10 seconds if no buttons are pressed.
6. To find additional stations press and release the **Auto Tune button** as before.
7. To scan the FM band in an opposite direction press and hold down either the **Tuning Up button** (to scan low frequency to high frequency) or **Tuning Down button** (to scan high frequency to low frequency) and then press the **Auto tune button** again.

When the end of the waveband is reached your radio will recommence tuning from the opposite end of the waveband.
9. Adjust the **Volume** to the required setting.

Standby

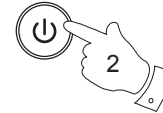

Band



• Full
Auto Tune

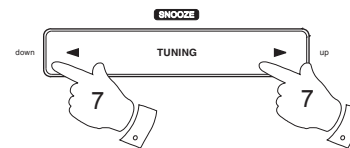

Manual tune - FM

1. Fully extend the wire aerial located on the rear of your clock radio. Place the wire antenna so that it is as straight as possible extending either above or below the radio.
2. Press the **On / Standby button** to switch on your clock radio.
3. Press the **Band button** to select the FM band.
4. Press the **Tuning Up** or **Down buttons** to tune to a station. The frequency will change in steps of 50kHz. Pressing and holding the buttons will advance the frequency several times each second. If the radio is tuned to a station of sufficient signal strength with RDS information present, then the display may change to show the station name.
5. When the end of the waveband is reached the radio will recommence tuning from the opposite end of the waveband.
6. Set the **Volume** to the desired setting.
7. To switch off your clock radio press the **Standby button**.

Note: The display will revert to a conventional time display 10 seconds after the last button press except when displaying scrolling text.

Standby

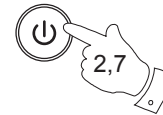

Band

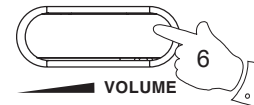
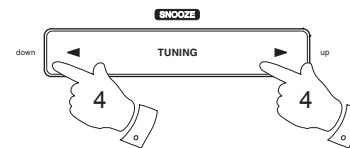
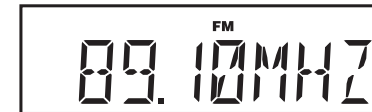

Display modes - FM

Your radio has a range of display options when in FM mode. Note that the display will revert to a conventional time display 10 seconds after the last button press except when displaying scrolling text.

The Radio Data System (RDS) is a system in which inaudible digital information is transmitted in addition to the normal FM radio programme. RDS offers several useful features.

1. Press the **Info button** to cycle through the various modes.

- | | |
|-------------------|---|
| a. Station name | Displays the name of the station being listened to. |
| b. Frequency | Displays the frequency of the station being listened to. |
| c. Scrolling text | Displays scrolling text messages such as artist/track name, phone in number, etc. |
| d. Programme type | Displays type of station being listened to e.g. Pop, Classic, News, etc. |
| e. Time | Displays the current time (24 hour clock). |
| f. Date | Displays the current date. |
| g. Day | Displays the current day of the week. |

Note: If no RDS information is available, the radio will be unable to display the station name, scrolling text and programme type information.

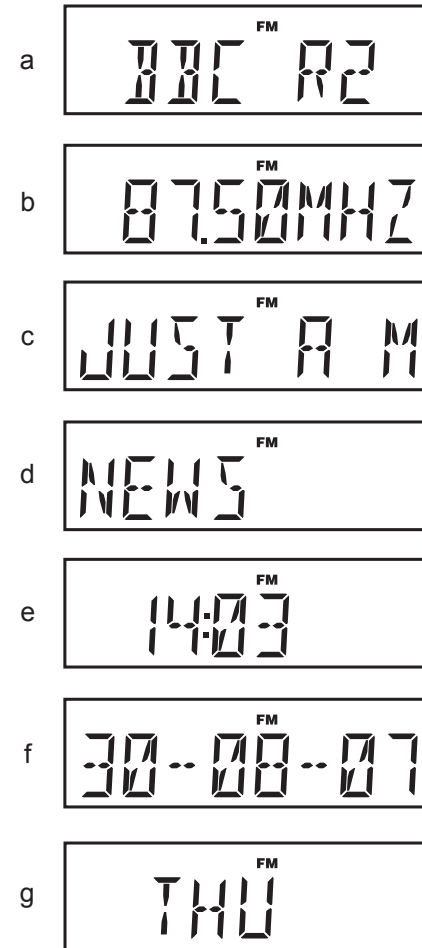
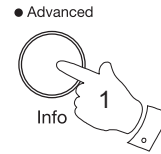

Presetting stations

You may store your preferred DAB and FM radio stations to the preset station memories. There are 10 memory presets in your radio, 5 for DAB and 5 for FM. Presets are remembered by your radio in the event of a power failure.

The procedure for setting presets and using them to tune stations is the same for FM and DAB modes, and is described below.

1. Press the **On / Standby button** to switch on the clock radio.
2. Tune to the required station as previously described.
3. Press and hold down the required **Preset button** until the display shows, for example, "P1 SAVED". The currently tuned station will be stored under the chosen preset button. Repeat this procedure for the remaining presets as needed.
4. Stations which have been stored in preset memories may be overwritten by following the above procedure.

Recalling a preset station

1. Press the **On / Standby button** to switch on the clock radio.
2. Press the **Band button** to select the desired waveband.
3. Momentarily press the required **Preset button**. Your clock radio will tune to the station stored in the preset memory.

Standby

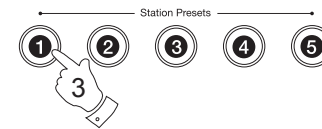
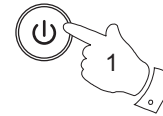

Standby

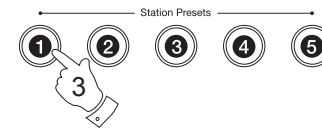
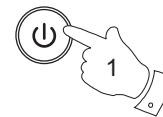

Band



Clock display

1. When your clock radio is in standby mode, the display normally shows the current time. The date can be displayed by pressing the **Info button**. After 10 seconds the display will return to showing the current time.

● Advanced



Display Dimmer

Your clock radio has an adjustable dimmer control located underneath the unit. The display brightness will be increased whenever a button is pressed for about 10 seconds and it will then revert to a lower level.

1. To increase the display brightness rotate the dimmer control clockwise.
2. To decrease the display brightness rotate the dimmer control anti-clockwise.

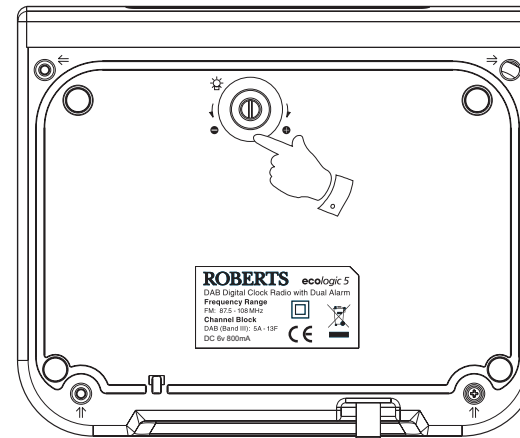

Display Backlight

1. In order to view the display when the display backlight is set to a low level, you can press any button (apart from the On / Standby button) to switch on the backlight without switching on the radio. The display brightness will increase for 10 seconds before returning to the previous level.

Setting the alarm times

Your clock radio has two alarms which can be set to wake you to either radio or buzzer alarm. Each alarm can be set to sound once, daily, on weekdays or at weekends. The alarms can only be set when your clock radio is switched on and in DAB or FM mode.

Note: If no buttons are pressed for 7 seconds, your clock radio will exit the alarm setup.

1. Press the **On / Standby button** to switch on the clock radio.
2. Press and release the **Alarm button**. The display will show "SET ALM".
3. Press the **Select button** to enter the alarm setup. "Alarm 1" flashes.
4. Press the **Tuning Up** or **Down buttons** to select the desired alarm number, 1 or 2.
5. Press the **Select button** to enter the setting for the chosen alarm. Press the **Tuning Up** or **Down buttons** to select ON or OFF. If OFF is selected any current setting for that alarm will be cancelled.
6. Press the **Select button** to cause the alarm hour digits to flash on the display.
7. Press the **Tuning Up** or **Down buttons** to choose the desired alarm hour.

Standby

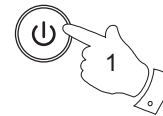

Alarm

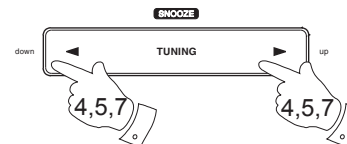

8. Press the **Select button** to enter the hour setting. The alarm minute digits will flash on the display.

9. Press the **Tuning Up** or **Down buttons** to choose the desired alarm minute.

10. Press the **Select button** to enter the minutes setting. The alarm day option will flash on the display.

11. Press the **Tuning Up** or **Down buttons** to select the desired alarm day option.

- Once - Will sound at one time only
- Daily - Will sound everyday
- Weekdays - Will sound only on weekdays
- Weekends - Will sound only at weekends

• If setting the alarm to once only, continue with step 12 below. Otherwise skip to step 18 on the following page.

12. Press the **Select button** to enter the setting. The alarm year will flash on the display.

13. Press the **Tuning Up** or **Down buttons** to choose the alarm year.

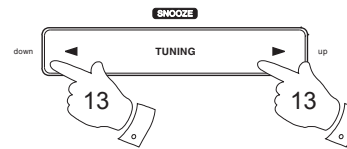
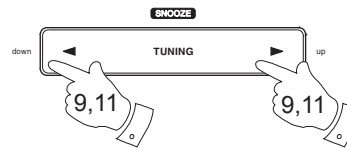
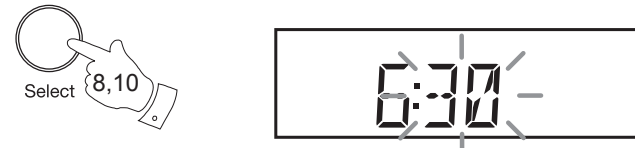

14. Press the **Select button** to enter the alarm year setting. The alarm month will flash on the display.

15. Press the **Tuning Up** or **Down buttons** to choose the alarm month.

16. Press the **Select button** to enter the alarm month setting. The alarm day will flash on the display.

17. Press the **Tuning Up** or **Down buttons** to choose the alarm day.

18. Press the **Select button** to enter the setting. The alarm source option will flash on the display.

19. Repeatedly press the **Tuning Up** or **Down buttons** to choose the desired alarm source (DAB, FM, BUZ).

20. Press the **Select button** to confirm the alarm settings and return to normal radio mode.

Active alarms (1 or 2) are indicated in the display by the corresponding alarm symbol 📻 📻.

Note: When your clock radio is set to wake by the radio alarm, your clock radio will switch to the last used station. Be sure to check that the volume is not set so low that you cannot hear the radio alarm.

IMPORTANT: The radio alarm will not be audible while you have any connection to the Aux In socket. The buzzer alarm may still be used.

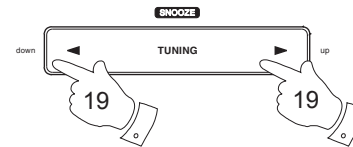
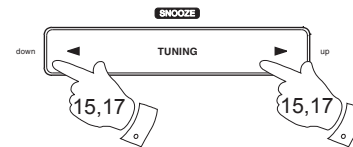
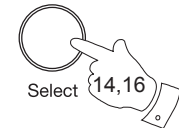

To view the alarm settings

1. Press the **On / Standby button** to switch on the clock radio.
2. Press the **Alarm button** to enter the alarm setup.
3. Press the **Select button**, then press the **Tuning Up or Down buttons** to view alarms 1 or 2.
4. Press the **Select button** to cycle through each of the settings for the chosen alarm.
You may use the Tuning Up and Down buttons to modify any particular setting if desired, using the Select button to enter the modification.

Alarm

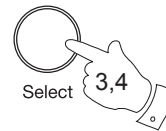
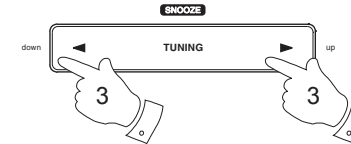
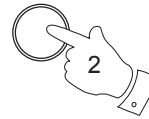

Cancelling alarms

1. While an alarm is sounding it can be cancelled by pressing the **On / Standby button**.

Standby

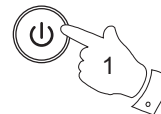

Snooze

1. When the radio or buzzer alarm sounds, pressing the **Snooze button** will silence the alarm for the selected number of minutes. The Snooze can be adjusted between 5 and 20 minutes in 5 minute increments. Default setting is 5 minutes. The display will show the Snooze symbol zz^z . This sequence can be repeated during the 60 minute beep alarm period.
2. To cancel the Snooze function, press the **Standby button**.

To set the snooze time

1. Press the **On / Standby button** to switch on the clock radio.
2. To set the snooze time, press the **Alarm button** to enter the settings menu. "SET ALM" will appear on the display.
3. Press the **Tuning Up** or **Down button** until "SNOOZE" appears on the display. Press and release the **Select button**. "SNOOZE05" will be displayed.
4. Press the **Tuning Up** or **Down buttons** to choose the desired snooze setting from between 5, 10, 15 and 20 minutes.
5. Press the **Select button** to enter the desired snooze duration. The radio will exit the menu options and return to the normal radio display.

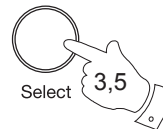
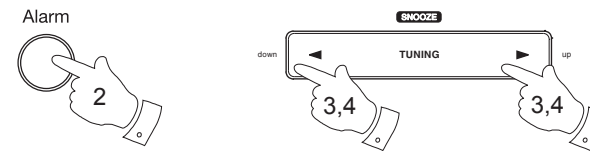
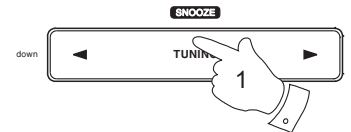

Sleep timer

Your clock radio can be set to turn off after a preset time has elapsed. The sleep setting can be adjusted between 5 and 90 minutes in 5 minute increments. Ensure your clock radio is switched On.

1. To set the desired sleep time, press and release the **Alarm button** to enter the settings menu. "SET ALM" will appear on the display.
2. Press the **Tuning Up** or **Down button** until "SLEEP" appears on the display. Press and release the **Select button**. "SLEEP 05" (or the previous sleep timer setting) will be displayed.
3. Press the **Tuning Up** or **Down button** to select the desired sleep time. The sleep setting will increase in 5 minute increments from 5 minutes up to 90 minutes. A further press will cause the sleep timer to be set to OFF which will cancel the sleep function.
4. Press the **Select button**. The display will show the sleep timer setting then exit the sleep options. The snooze indicator will be activated to show that the sleep timer is in use.
5. Your clock radio will switch off after the preset sleep time has elapsed.
6. To cancel the sleep timer function before the preset time has elapsed, press the **Standby button**.
To cancel the sleep timer without switching off your radio, use the procedure above and select the "OFF" setting.

Alarm

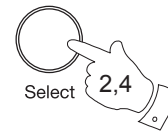
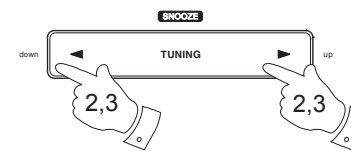

Standby

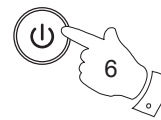

Setting the clock manually

Normally your clock radio will set its clock automatically via the DAB signal. If no DAB signal is available and you need to set the time manually, please follow the procedure shown below.

Note: The DAB signal will always override any manual time setting.

1. To set the clock time, press the **On / Standby button** to switch on the clock radio. Press the **Alarm button** to enter the menu setup. "SET ALM" will appear on the display.
2. Press the **Tuning Up** or **Down button** until "MANU CLK" appears on the display. Press and release the **Select button** to enter the manual setting procedure. The hour digits will then flash on the display.
3. Press the **Tuning Up** or **Down buttons** to select the desired hour.
4. Press the **Select button** the minute digits will flash on the display.
5. Press the **Tuning Up** or **Down buttons** to select the desired minute.



6. Press the **Select button** to enter the minutes setting. The year will then flash on the display.
7. Press the **Tuning Up** or **Down buttons** to change the year as needed.
8. Press the **Select button** to enter the year setting. The month will then flash on the display.
9. Press the **Tuning Up** or **Down buttons** to select the current month.
10. Press the **Select button** to enter the month setting. The day in the month will then flash on the display.
11. Press the **Tuning Up** or **Down buttons** to select the current day.
12. Press the **Select button** to confirm the time setting and return to normal radio clock display.

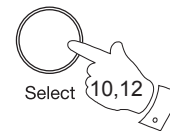
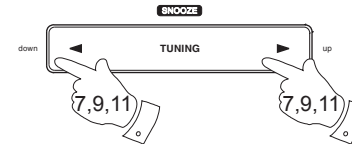
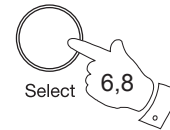

To return to auto clock set mode

1. Press the **On / Standby button** to switch on the clock radio. Press the **Alarm button** to enter the settings menu. "SET ALM" will appear on the display.
2. Press the **Tuning Up** or **Down button** until "AUTO CLK" appears on the display. Press and release the **Select button**.

Note: If you select "AUTO CLK" the current time received will be displayed. If no DAB signal is found, "NO DABCK" will be displayed. You should then either position the radio or its aerial so that a signal can be received, or revert to manual clock mode (see page 23).

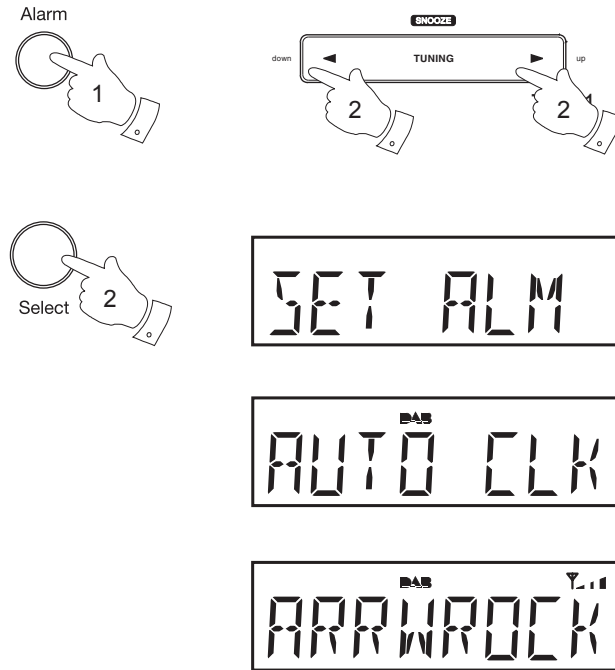

Auxiliary input socket

1. A 3.5mm stereo **Auxiliary Input socket** is provided on the right hand side of your clock radio to permit an audio signal to be fed into the unit from an external audio device such as iPod, MP3 or CD player. Connecting to this socket will override the radio functions
2. Adjust the volume control on your iPod, MP3 or CD player to a reasonably high level, and then adjust the **Volume control** on your clock radio for comfortable listening.

IMPORTANT: The radio alarm will not be audible while you have any connection to the Aux in socket. The buzzer alarm may still be used.

Note: When you connect the audio source your clock radio will be muted. To be able to listen to DAB or FM radio, you must disconnect your player from the **Aux In socket**.

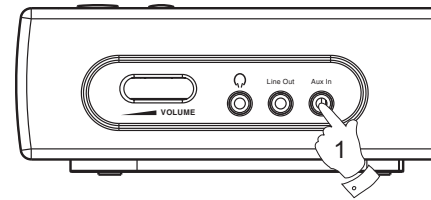

Headphone socket

A 3.5mm **Headphone Socket** located on the right hand side of your clock radio is provided for use with either headphones or an earpiece. Inserting a plug automatically mutes the internal loudspeaker.

IMPORTANT: Excessive sound pressure from earphones and headphones can cause hearing loss.

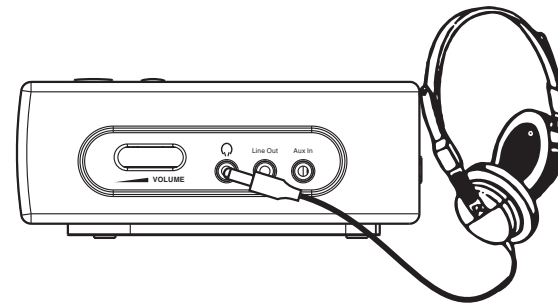

Line out socket

A 3.5mm **Line out socket** located on the right hand side of your clock radio is provided for connecting the audio signal to an external amplifier. Inserting a plug into the line output socket will not mute the internal loudspeaker.

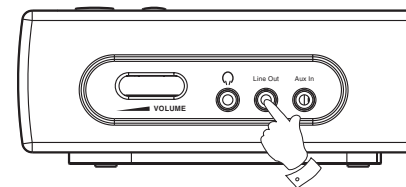

Software version

The software display cannot be altered and is just for your reference. Ensure your clock radio is switched to the On position.

1. Press and hold the **Info button** the display will show "MANUAL".
2. Press the **Tuning Up or Down buttons** until the display shows your clock radios software information.
3. After a few seconds your clock radio will return to normal radio mode.

● Advanced

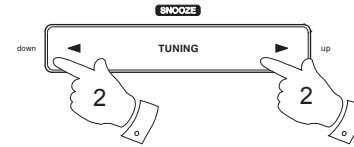
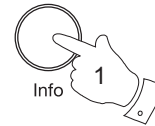

System reset

If your radio fails to operate correctly, or some digits on the display are missing or incomplete carry out the following procedure.

1. Switch on your radio.
2. Press and hold in the **Info button** until "MANUAL" appears on the display.
3. Press the **Tuning Up** or **Down button** until "FACTORY" appears on the display, press the **Select button** the display shows "RESET" and then press the **Select button** again.
5. A full reset will be performed, the station list and presets will be erased. The display will show "ROBERTS" and after a few seconds a station scan search will be performed automatically. The display will show progress of the station search e.g. ">>>> 18". The number on the right of the display is the number of stations that have been found.

In case of malfunction due to electrostatic discharge, reset the product (reconnection of power source may be required) to resume normal operation.

If a problem persists our technical staff would be pleased to offer any assistance on operating the radio. Our technical helpline number is 020 8758 0338.

• Advanced

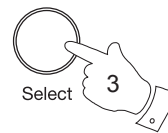
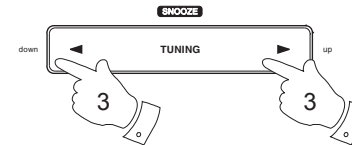
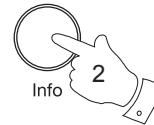

Cautions

Do not allow this clock radio to be exposed to water, steam or sand. Do not leave your clock radio where excessive heat could cause damage such as in a parked car where the heat from the sun can build up even though the outside temperature may not seem too high.

- The name plate is located on the underside of the unit.

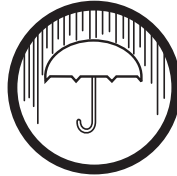

- Your clock radio should not be exposed to dripping or splashing and that no objects filled with liquids, such as vases, shall be placed on the clock radio.
- It is recommended to operate the product such that there is a minimum distance (10cm recommended) to adjacent objects in order to ensure good ventilation.
- The ventilation of the product should not be restricted by covering it or its ventilation openings with items such as newspapers, tablecloths, curtains etc.
- No naked flame sources such as lighted candles should be placed on the product.
- It is recommended to avoid using or storing the product at extremes of temperature. Avoid leaving the unit in cars, on window sills, in direct sunlight etc.

Specifications

Power Requirements

Mains AC 100 \sim 240V 50/60 Hz (switching adaptor)

Frequency Coverage

FM	87.5-108MHz
DAB	174.928 - 239.200MHz

Circuit Features

Loudspeaker	1 x 75mm
Output Power	0.6 Watt
Headphone socket	3.5mm dia
Auxiliary Input socket	3.5mm dia
Line out socket	3.5mm dia
Aerial System	FM Wire aerial
	DAB Wire aerial

The Company reserves the right to amend the specification without notice.

Guarantee

This instrument is guaranteed for twelve months from the date of delivery to the original owner against failure due to faulty workmanship or component breakdown, subject to the procedure stated below. Should any component or part fail during this guarantee period it will be repaired or replaced free of charge.

The guarantee does not cover:

1. Damage resulting from incorrect use.
2. Consequential damage.
3. Receivers with removed or defaced serial numbers.

Procedure:

Any claim under this guarantee should be made through the dealer from whom the instrument was purchased. It is likely that your Roberts' dealer will be able to attend to any defect quickly and efficiently but should it be necessary the dealer will return the instrument to the Company's service department for attention. In the event that it is not possible to return the instrument to the Roberts' dealer from whom it was purchased, please contact Roberts Radio Technical Services at the address shown on the rear of this manual.

These statements do not affect the statutory rights of a consumer.

ROBERTS RADIO TECHNICAL SERVICES

97-99 Worton Road

Isleworth

Middlesex

TW7 6EG

Technical Helpline :- 020 8758 0338 (Mon-Fri during office hours)

Website: <http://www.robertsradio.co.uk>

© 2008 Roberts Radio Limited



Issue 1

